

tio



RF Thermostat with Single Channel Receiver Installation & User Manual

Your SmartLife journey begins now



Scan the QR code and download
the SmartLife app now to
optimise your thermostats
functionality.



About your thermostat...

A modern touch key Wi-Fi smart thermostat.

You can use a mobile device to control your thermostat anywhere.

It can be used to replace most common residential thermostats and is designed to be used with a variety of different heating systems.

This is a wireless unit and connects remotely with a receiver that can be wired directly to your heating system.

This model is not suitable for switching electric heating systems with a load greater than 3A.

TIOSTA0012 meets UKCA, CE and RoHS standards.

Your thermostat requires 2x AA batteries
(not included)

Contents

Overview	5
Thermostat Functions	7
Receiver Functions	8
Configuration Menu	11
Factory Settings	12
Programming your thermostat	13
Programming your thermostat	15
Voice Control	18
Troubleshooting	19

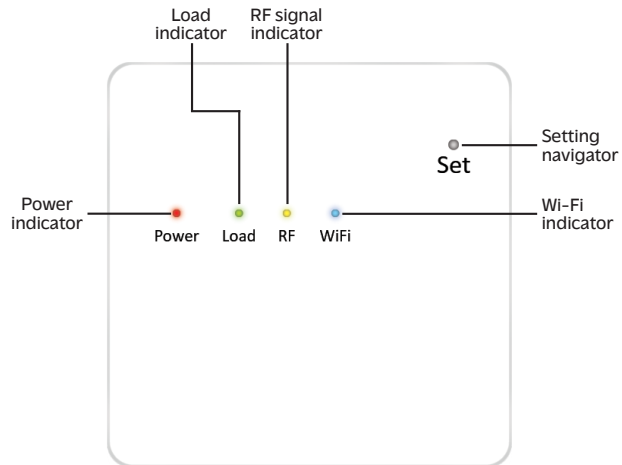
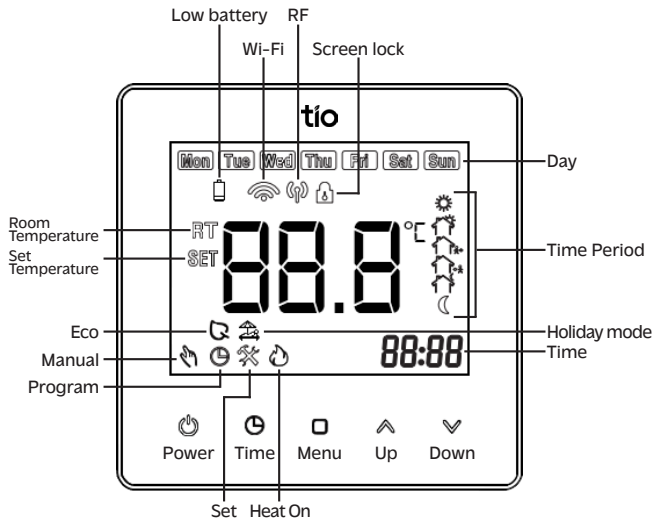

Thermostat Functions

- 🔌 Press this button to power your thermostat on or off.
- 🕒 Time setting button to set minute, hour and day.
- ☐ Menu button which allows you to change between manual and programme mode.

Manual mode: Press ☐ to select manual mode. A 🖱️ symbol will appear in the bottom left corner when this mode has been selected. You can now set your desired temperature using ^ v.

Programme mode: Please see Page 13.

Holiday mode: Please see Page 14.

Temporary mode: During programme mode, you can manually change the temperature if required. You may use ^ v to set the temperature accordingly. Both 🖱️ 🕒 icons will appear on screen. Your pre-programmed settings will return in the next period.

Child lock: Press and hold ^ v over 5 seconds to lock/unlock your thermostat.

Programme reset: Press ☐ over 5 seconds to enter programme mode. Next, hold ^ v over 5 seconds. Your thermostat's programme settings have reset when 'def' flashes on screen.

Configuration reset: Press ^ v whilst in the configuration menu over 5 seconds until 'def' flashes on screen. This resets all the configuration settings.

Receiver Functions

Power indicator: Press the Set button to power on/off the receiver. The indicator will illuminate a red light when powered on.

Wi-Fi signal indicator: Whilst powered on, press and hold the Set button over 7 seconds until the indicator is flashing.

Slow Blink - 2.4GHz (preferred option for most devices and homes)

Rapid Blink - 5.0GHz (faster, but offers shorter signal range to router)

Rapid blink also gives access to AP configuration mode (Page 17).

Once paired, the blue light will remain illuminated. If the connection process fails, the light will turn off.

Load indicator: This indicator symbolises when the system is in operation. Whilst normally operating, the light will illuminate green. This indicator will turn off when there is no active operation.

RF signal indicator: A continuously illuminated light indicates that the thermostat and receiver are both in pairing mode.

With the receiver powered off, press and hold the Set button over 7 seconds. The receiver will now match the code. The indicator will blink 3 times when the thermostat and receiver have successfully paired.

A quick flashing indicator means that the receiver has received the signal from the thermostat successfully. This will occur with each signal sent.



Emergency output: If the thermostat becomes faulty and cannot communicate with the receiver, an emergency output can be initiated using the following method.

Power off the receiver. Press and hold the Set button until the RF signal indicator is switched on. After 20 seconds, the load and RF indicator will illuminate simultaneously. Short press Set to exit this function.

Manual connection

Under very rare circumstances, your receiver may not connect to your thermostat or the connection may drop. Please follow the upcoming instructions to establish a connection.

1. With the receiver powered off, press and hold the Set button over 7 seconds. The yellow indicator should now illuminate.

2. With your thermostat off, press  and  over 7 seconds. The LCD will display “---”. Once the connection has been established, the LCD will display a number (anything between 1-9 is within acceptable range).

3. Your thermostats RF symbol will now appear and the receiver's yellow indication will rapidly blink 3 times.





 RF symbol conditions:

Flashing: Receivers RF code does not match the thermostat.

Off: No RF signal connection.

On: Working as normal.

Configuration Menu

Firstly power off your thermostat. Next, press and hold  over 7 seconds to enter the configuration menu. During this menu, short press  to change functions and   for settings. Press  to confirm the setting.

No.	Function	Setting Options	Default
1	Temperature calibration	-9°C to 9°C	0°C
2	Dead zone	0.5°C to 5°C	1°C
3	Lock screen	0: All lock excluding power button. 1: All lock	0
4	Min. settable temperature	5°C to 20°C	5°C
5	Max. settable temperature	20°C to 35°C	35°C
6	High temperature protection <small>(Cannot be used on this model)</small>	25°C to 70°C	45°C
7	Display mode	0: Room temperature 1: Set temperature	0
8	Anti-freeze	0: OFF 1: ON. When room temp =5°C, heat on. Temp over 8°C, heat off.	0
9	Eco mode	0: OFF 1: ON	0
10	Eco mode temp. range	5°C to 30°C	16°C

Factory Settings

Please familiarise yourself with the thermostats pre-programmed factory settings.

Time Display	Monday - Friday		Saturday		Sunday	
	Time	Set Temperature	Time	Set Temperature	Time	Set Temperature
Period 1	06:00	22°C	06:00	22°C	06:00	22°C
Period 2	08:00	16°C	08:00	16°C	08:00	16°C
Period 3	12:00	22°C	12:00	22°C	12:00	22°C
Period 4	14:00	16°C	14:00	16°C	14:00	16°C
Period 5	18:00	22°C	18:00	22°C	18:00	22°C
Period 6	22:00	16°C	22:00	16°C	22:00	16°C

Before configuring your thermostat, please consider key parts of your day in order to maximise it's efficiency and efficacy.

Please remember that your underfloor heating will need a longer period of time to heat up when compared to your typical radiator system. With this in mind, it is advised to have your heating turn on roughly an hour in advance.



Programming Mode

When in programming mode, the screen will display the clock  symbol in the bottom left hand corner.

To enter programming options:

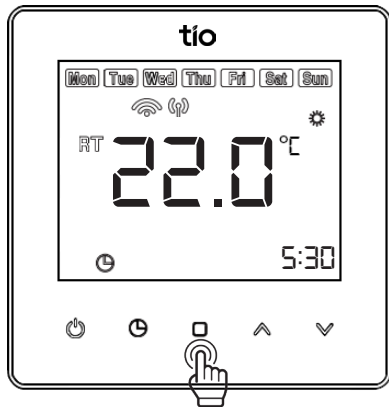
1. Press and hold  for 5 seconds.





2. Once in programming mode, press  to sequence through each time period and using   to set your desired preferences.

Day	Mon
Time	5:30
Temperature	22°C
Period	

Holiday Mode

1. With the thermostat on, long press  for 7 seconds to enter holiday mode.

2. Short press   button to set the day and temperature parameters you need.

3. Press  to exit this.

4. To exit holiday mode, short press .



You can control your devices with voice control by integrating your amazon echo or google assistant.

Integrating a simple user friendly interface with elegant features for pleasant and straightforward control over your devices.

You can remotely control your heating from anywhere with a Wi-Fi connection. With the option to also share control of the devices among family members.

Getting connected:

1. Start with installing the SmartLife app on your mobile device.
2. Open the application and register for an account.
3. The app will automatically detect your country code. In case it does not detect, you will be required to submit manually.
4. You will receive a verification code in order to confirm your details.
5. Click on the plus icon in the top right of the app to add a device.
6. The app should automatically pair with the device.
If the connection fails, you will be required to pair with the app manually.
7. Please follow the on-screen prompts to connect your device manually.

App Connection

AP configuration mode is setup by first, powering on your thermostat.

Next, set your receiver into AP configuration mode (Page 8).

Now on the SmartLife app, when selecting your thermostat, check the 'indicator is blinking slowly' box and press next.

You will now be prompted to select your network and enter the associated password.

Press 'Connect' on the next prompt to begin the connection process.

Your device will now take a moment to establish and complete the connection.

Voice control

Select  icon to access the settings menu. You can now access both Alexa and Google Assistant under the "Third-Party Control" tab.

Please note that the compatibility and connection between the Smart Life app and third-party voice control platforms is facilitated via Smart Life and not Tio Climate Solutions Ltd.

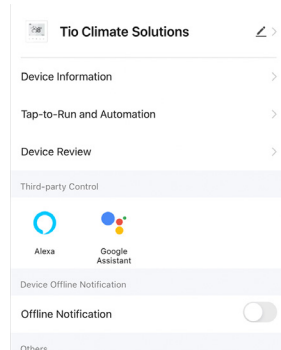
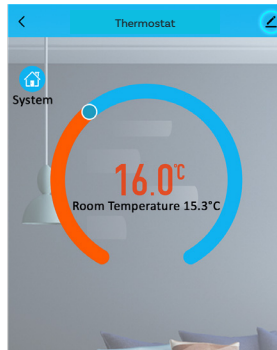

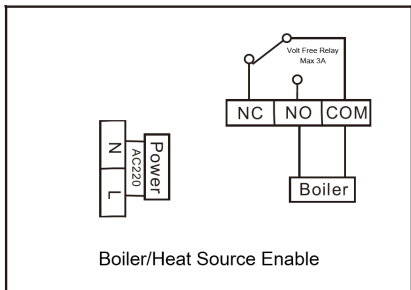
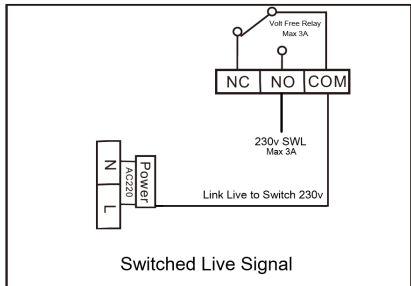

1 If your thermostat is displaying a room temperature which is not accurate - please recalibrate by using the dead zone configuration. (Page 7)

2 ❄️ Anti Freeze Function: When thermostat detects a room temperature of lower than or equal to 5°C, the thermostat will activate the heating. Once a room temperature of 8°C is detected, the heating will turn OFF.

3 🔋 Low battery alarm: Low battery icon will display when the battery is down to 10%. The icon will flash when the battery is down to 1%. At this stage you should replace with new batteries immediately, as the thermostat will stop functioning.

To reset the thermostats Wi-Fi chip, press the power button over 7 seconds. You will notice that the Wi-Fi symbol will start flashing. This means that the Wi-Fi has been reset.

4 Repeat this process to switch Wi-Fi frequency.
 Slow Blink - 2.4GHz (preferred option for most devices and homes)
 Rapid Blink - 5.0GHz (faster, but offers shorter signal range to router)

tio

www.tioclimateolutions.co.uk

